

ATTACHMENT A
Project Location Map

Legend

- Alternative A1
- - Tunnel
- Alternative A2
- Alternative C3-C5
- - Tunnel
- Alternative C3
- Alternative C4
- Alternative C5
- Alternative F
- - Tunnel
- Highway 101
- Existing Highway 101 (No Build)

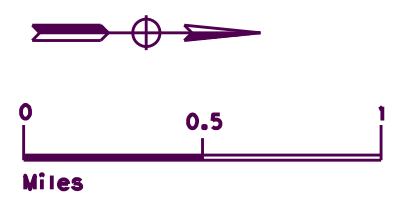

Special Locations

- 1 Wilson Creek
- 2, 3 Coastal Trail Crossing
- 4 Damnation Creek Trailhead
- 5 Mill Creek Campground Road
- 6 Cushing Creek
- 7 Hamilton Road

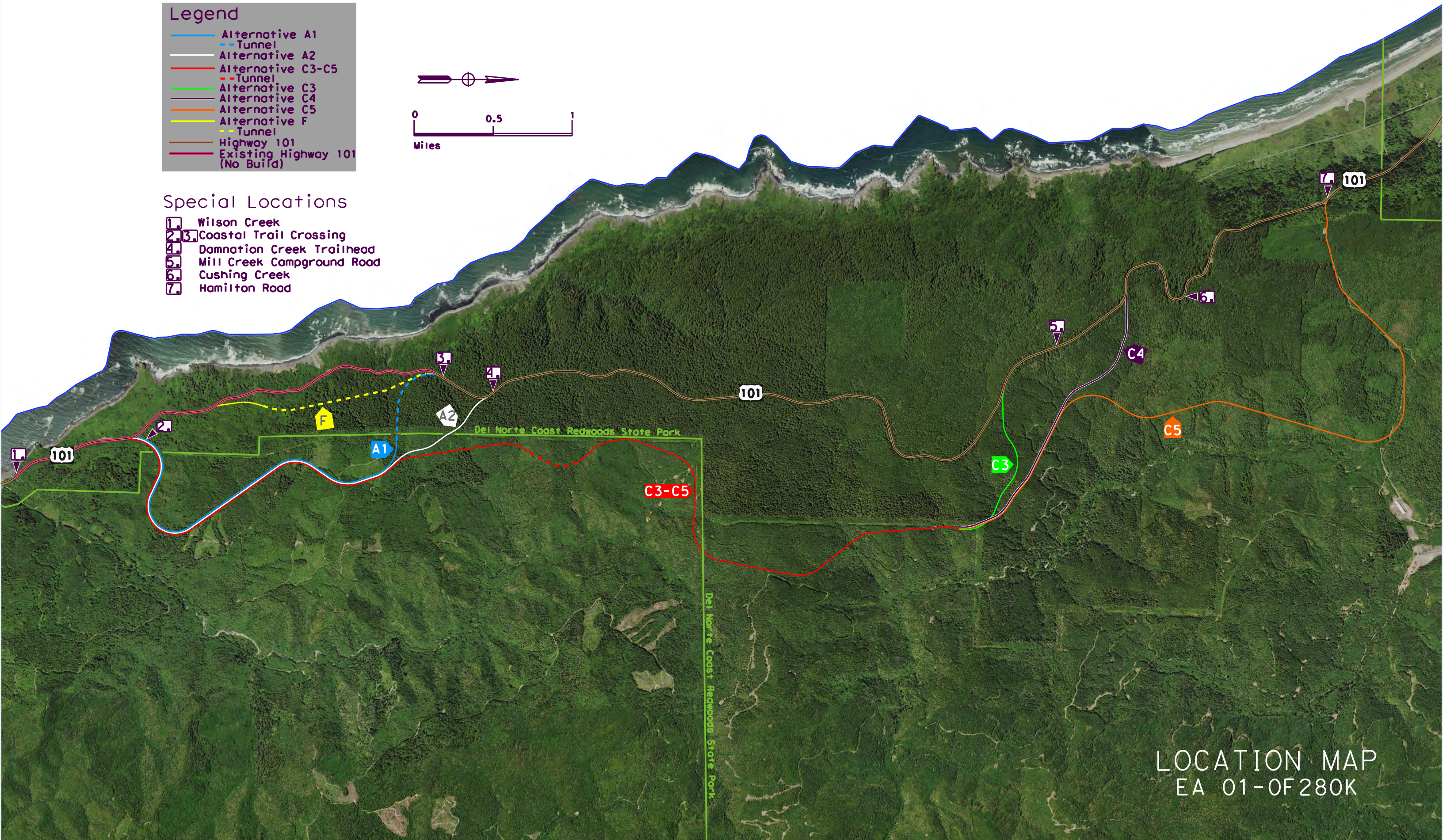

ATTACHMENT B
Layouts & Profiles



0' 1,000'

Scale



LAYOUT & PROFILE
EXISTING GRADE
EA 01-OF280K

PROFILE

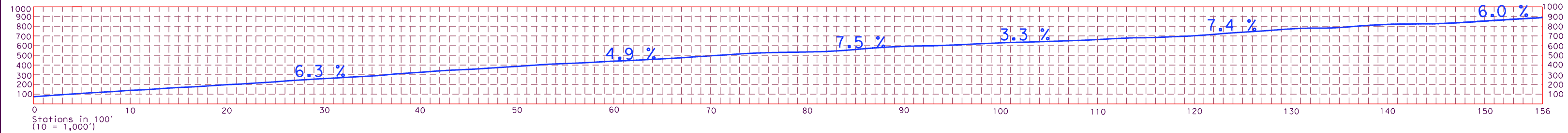

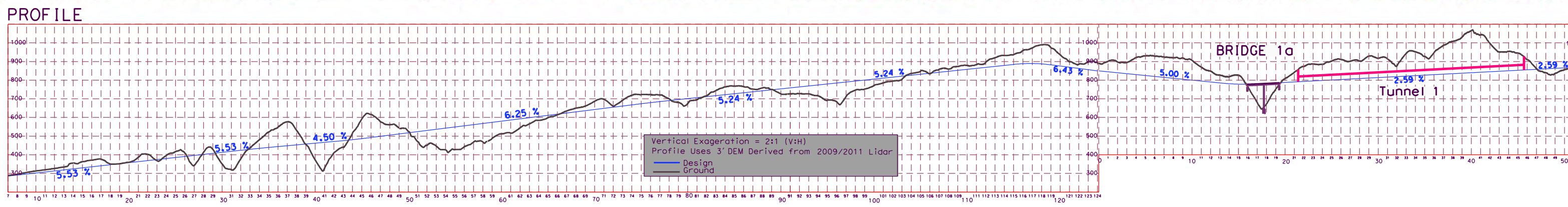
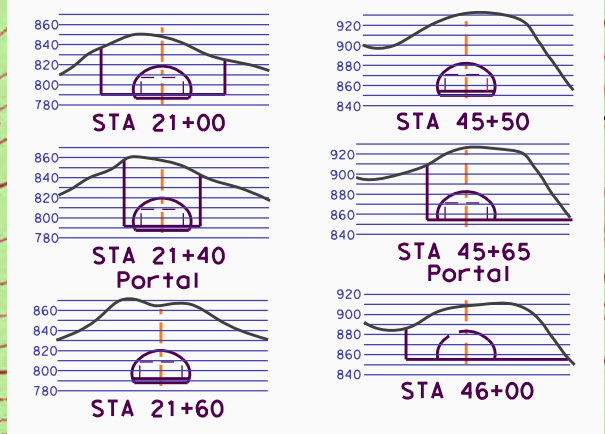
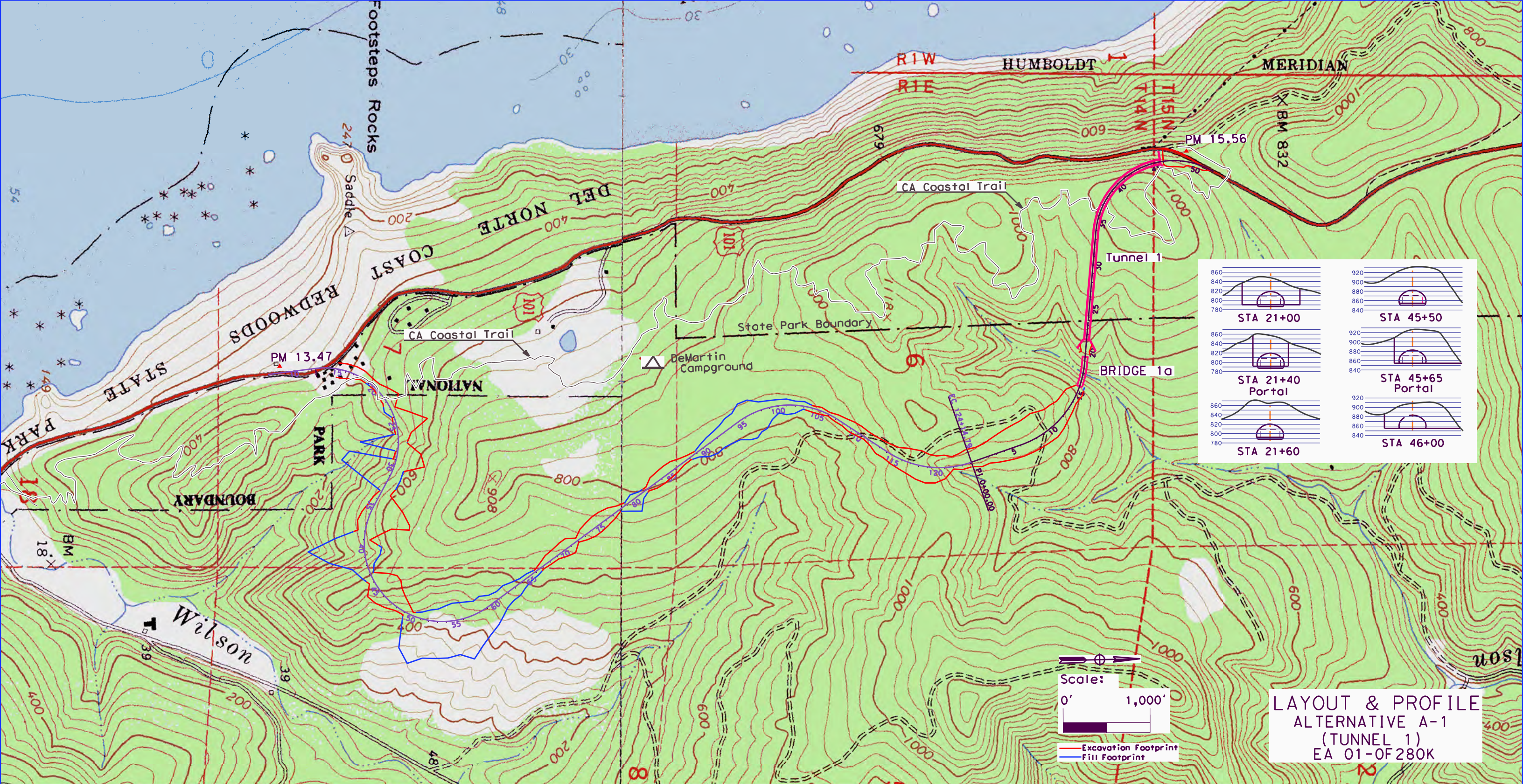

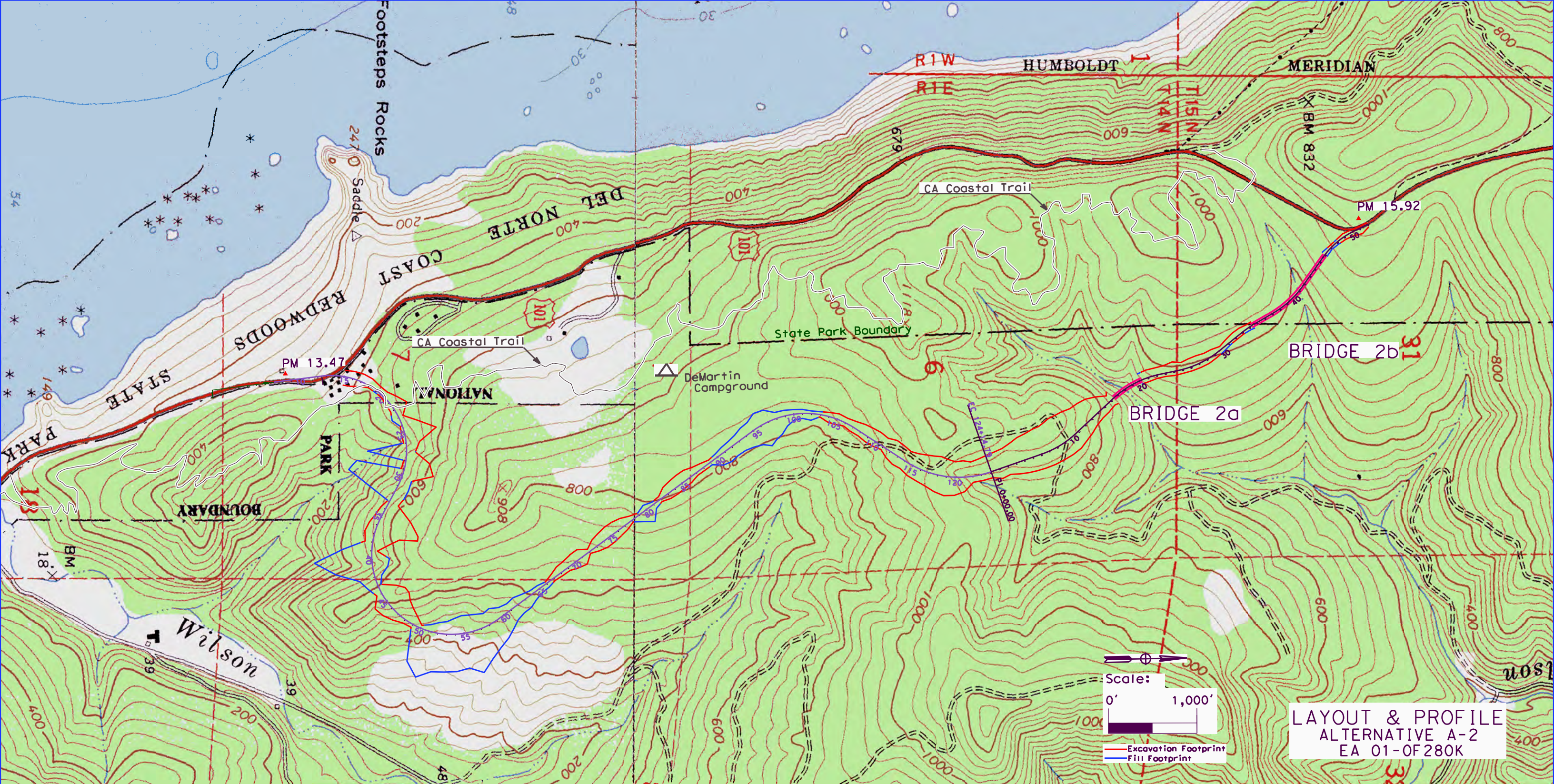

LAYOUT & PROFILE
 ALTERNATIVE A-2
 EA 01-OF280K

PROFILE

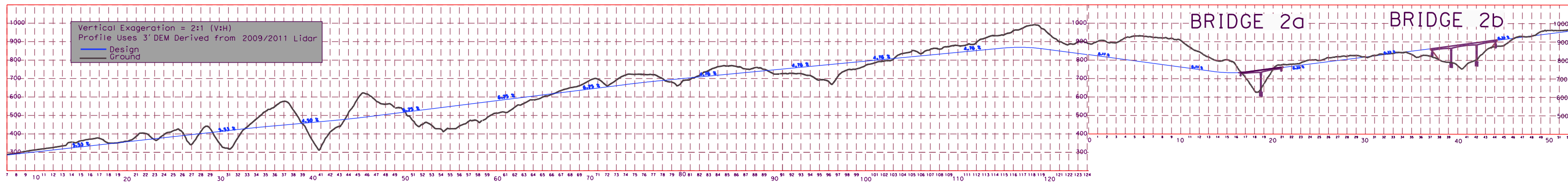

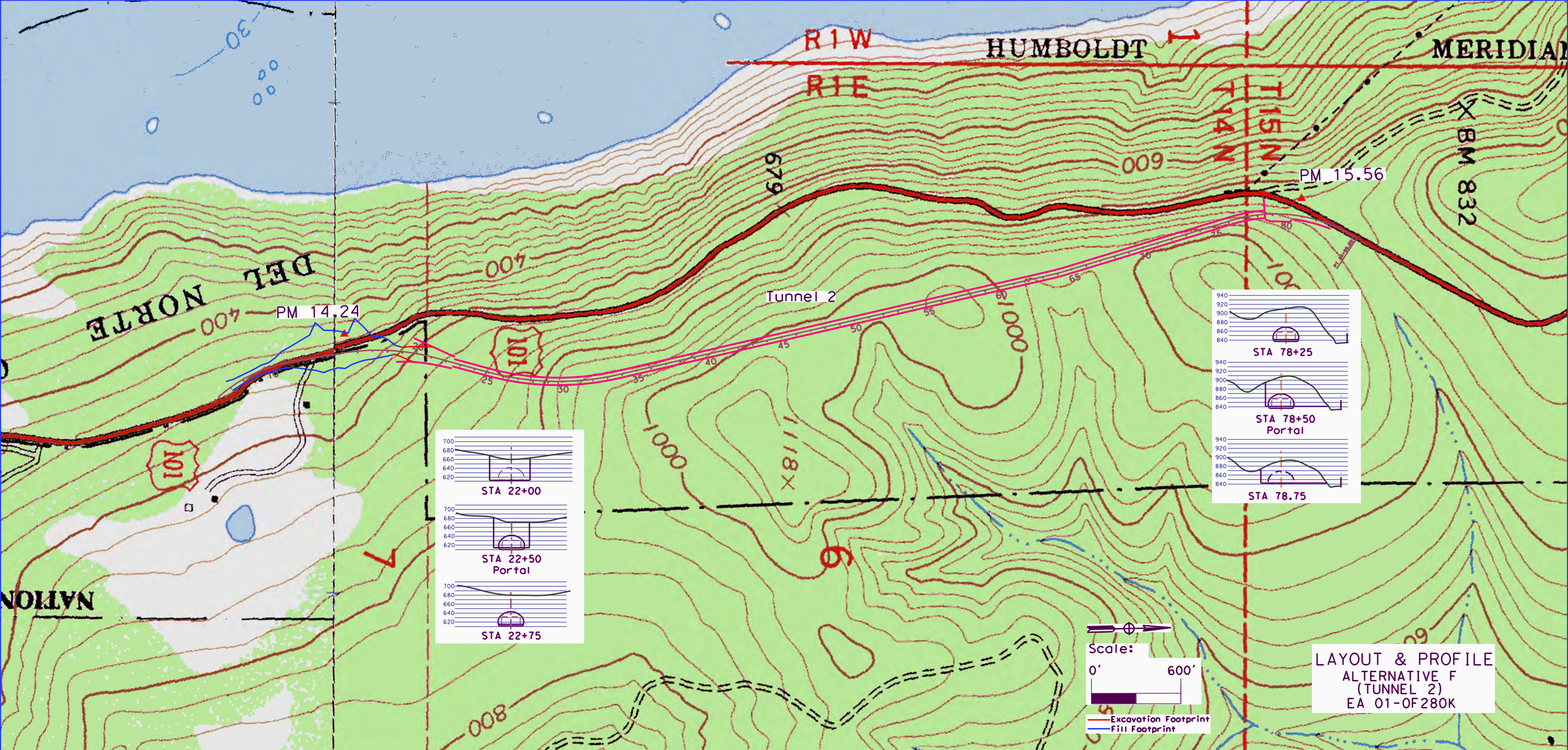

PROFILE

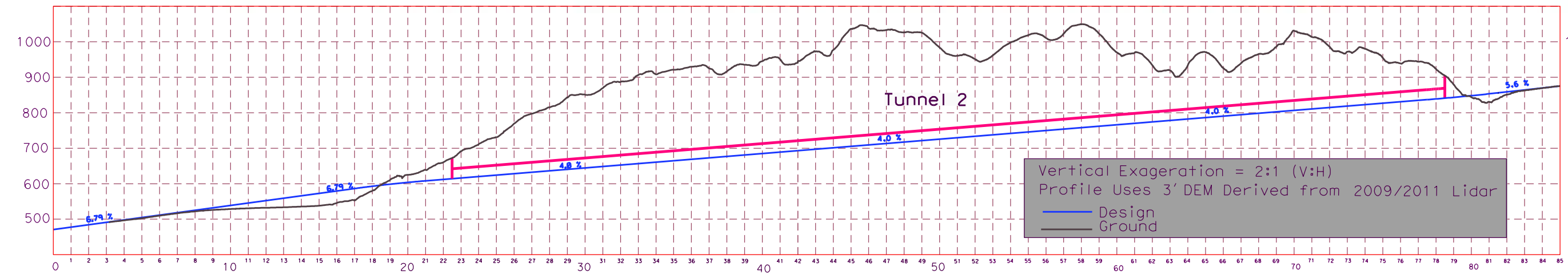

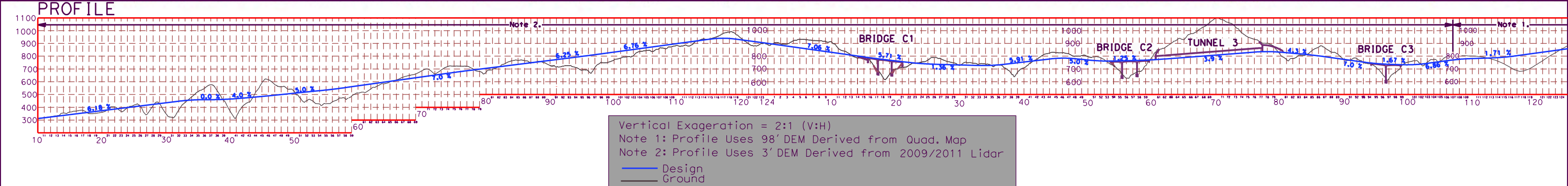
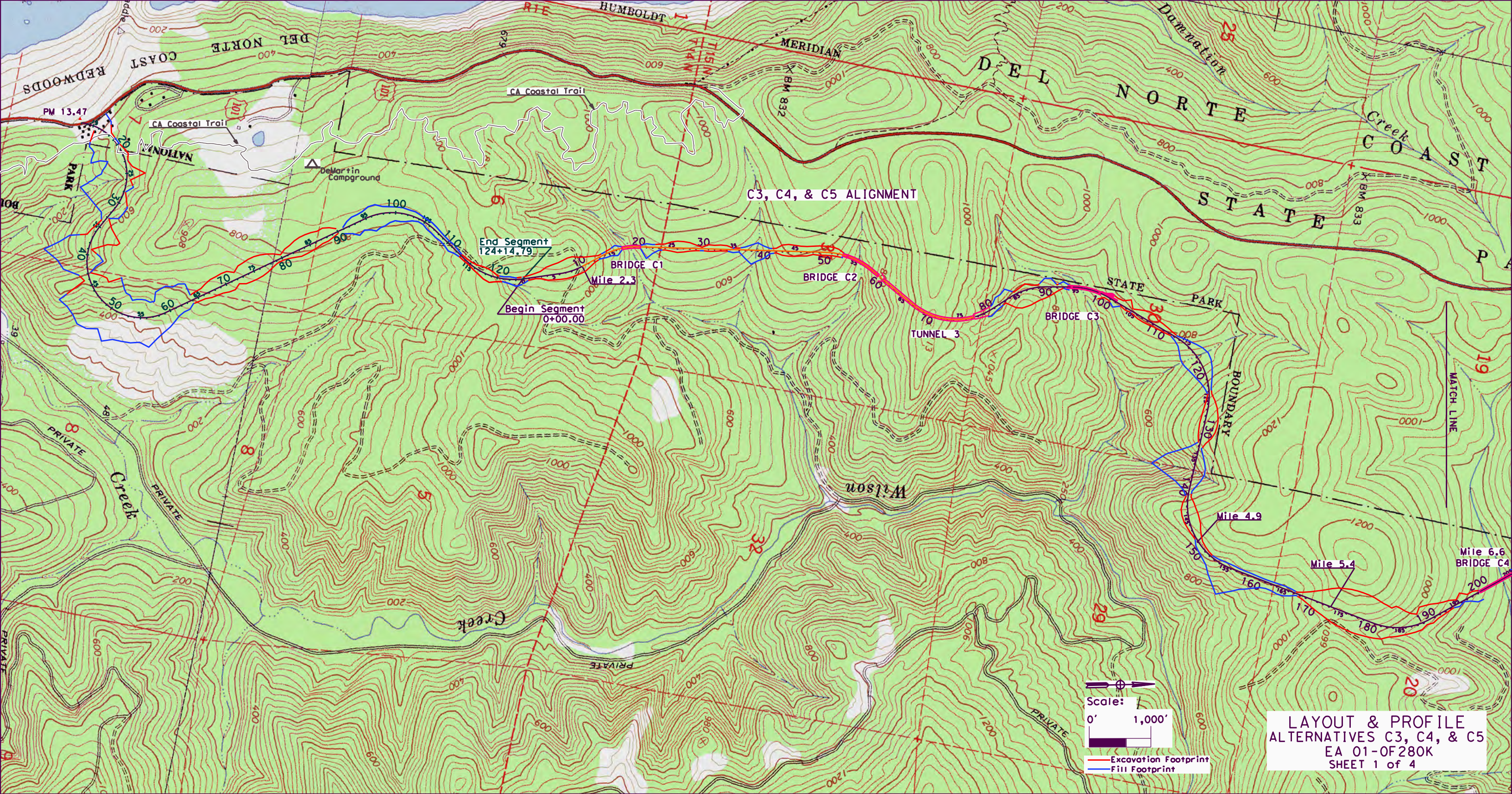

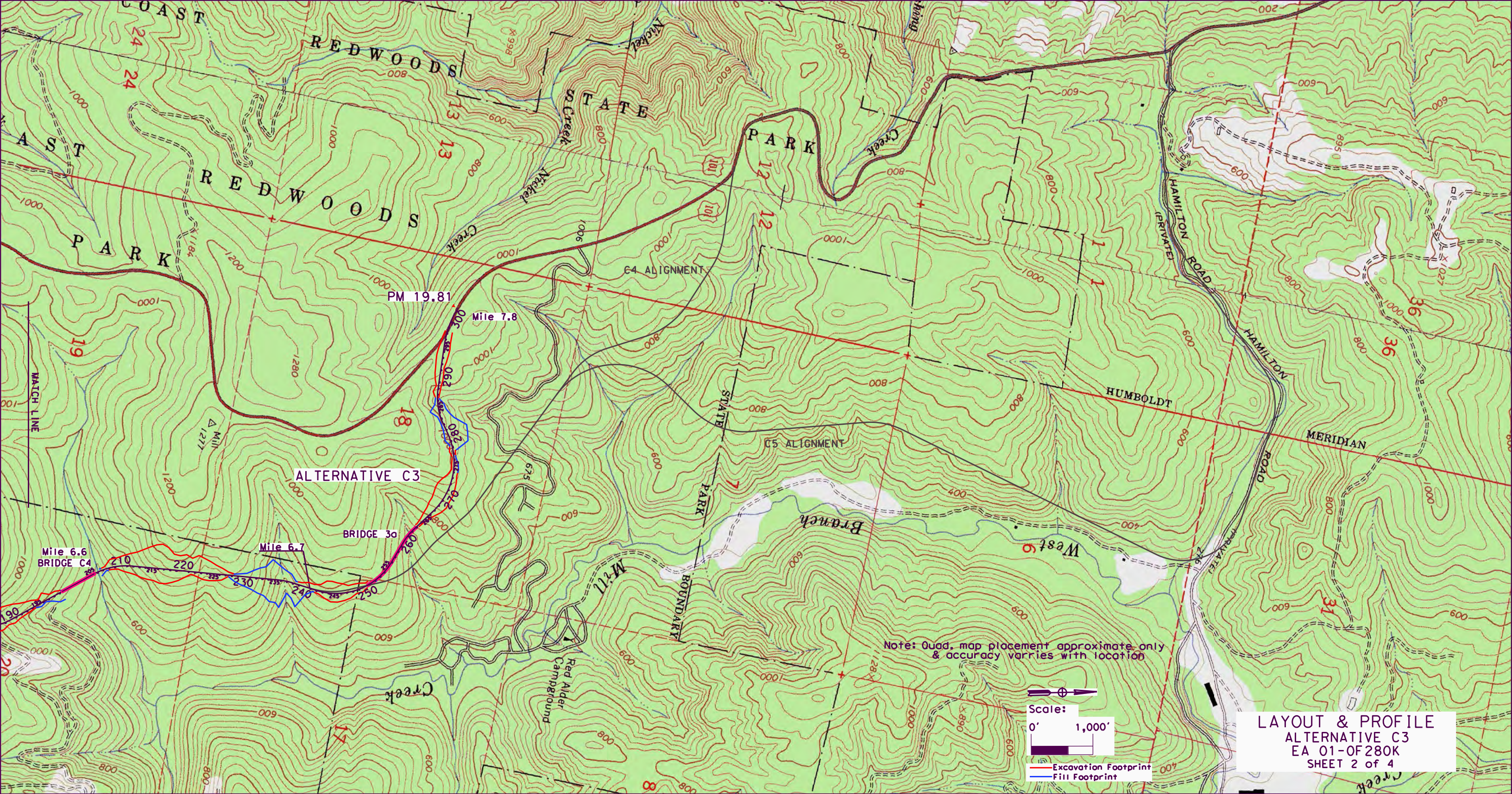

LAYOUT & PROFILE
 ALTERNATIVE C3
 EA 01-OF280K
 SHEET 2 of 4

Vertical Exaggeration = 2:1 (V:H)
 Note 1: Profile Uses 98' DEM Derived from Quad. Map
 Note 2: Profile Uses 3' DEM Derived from 2009/2011 Lidar

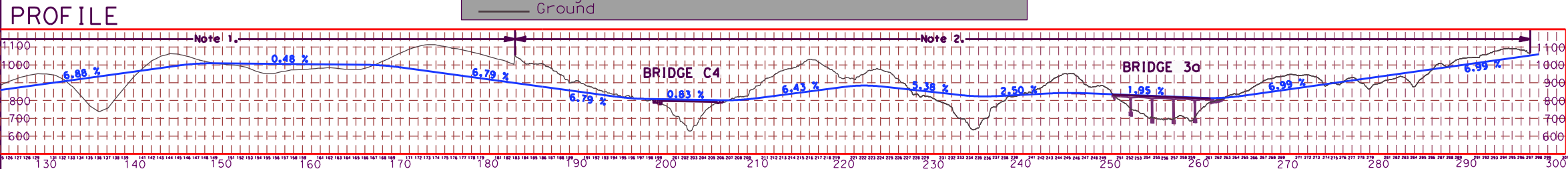

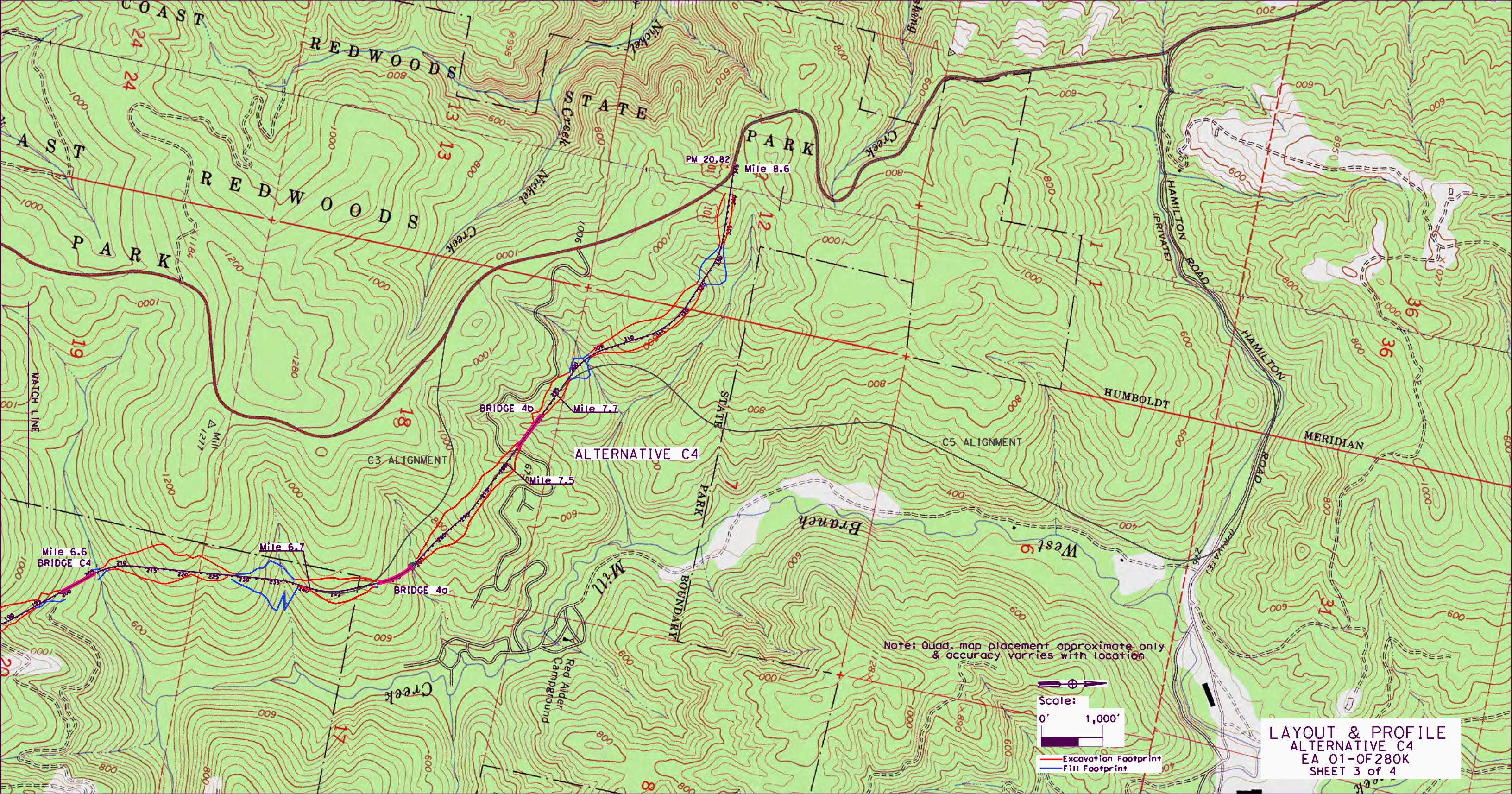

LAYOUT & PROFILE
 ALTERNATIVE C4
 EA 01-OF280K
 SHEET 3 of 4

Vertical Exaggeration = 2:1 (V:H)
 Note 1: Profile Uses 98' DEM Derived from Quad, Map
 Note 2: Profile Uses 3' DEM Derived from 2009/2011 Lidar

— Design
 — Ground

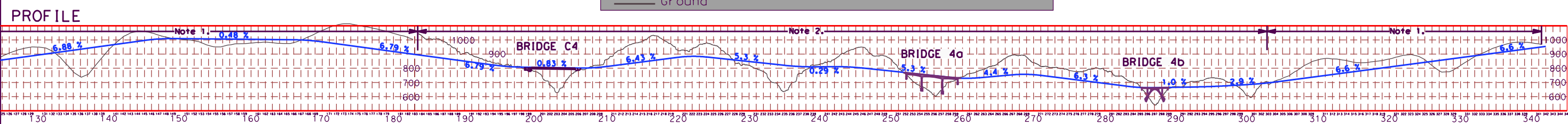

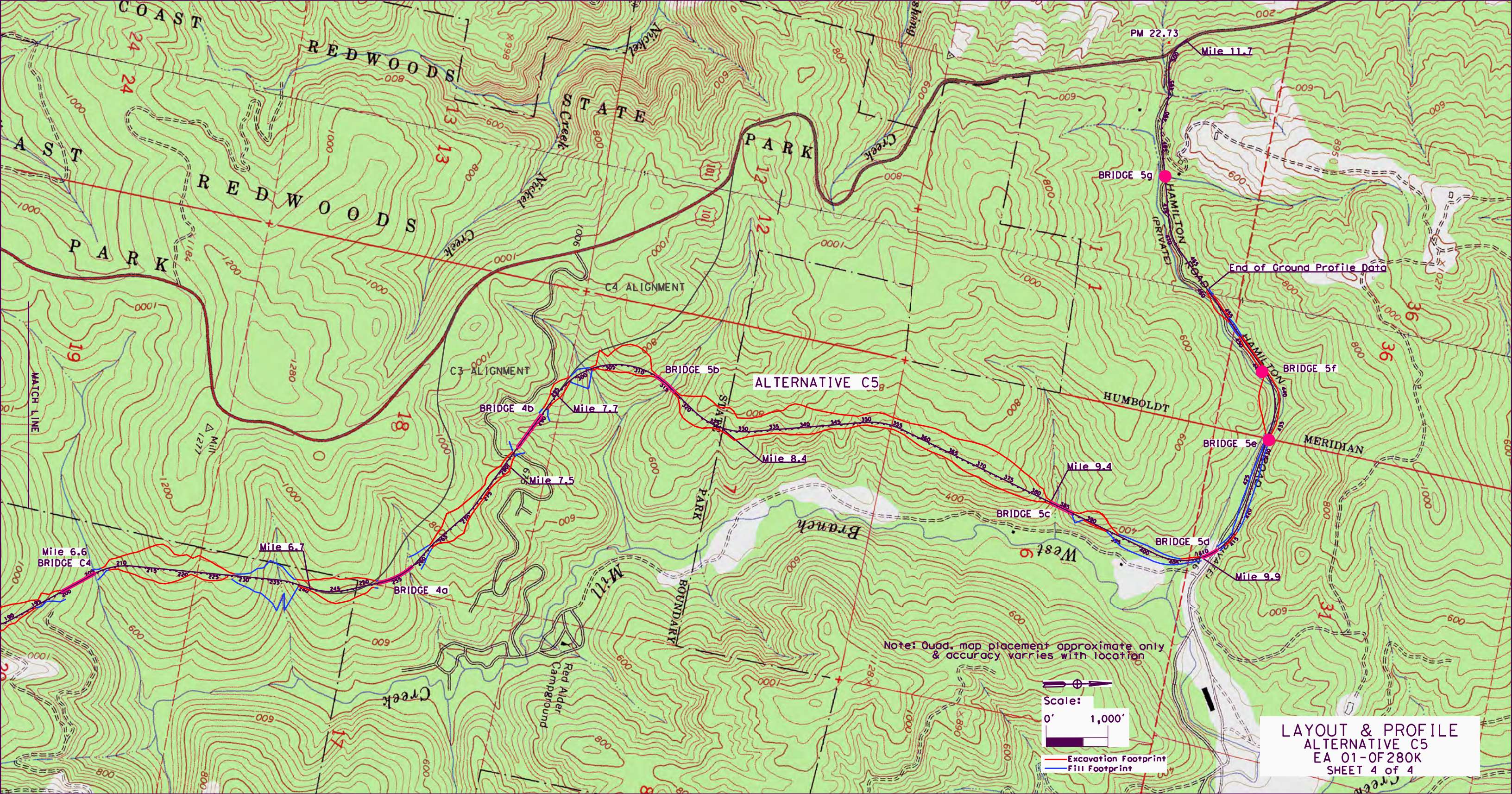

LAYOUT & PROFILE
 ALTERNATIVE C5
 EA 01-OF280K
 SHEET 4 of 4

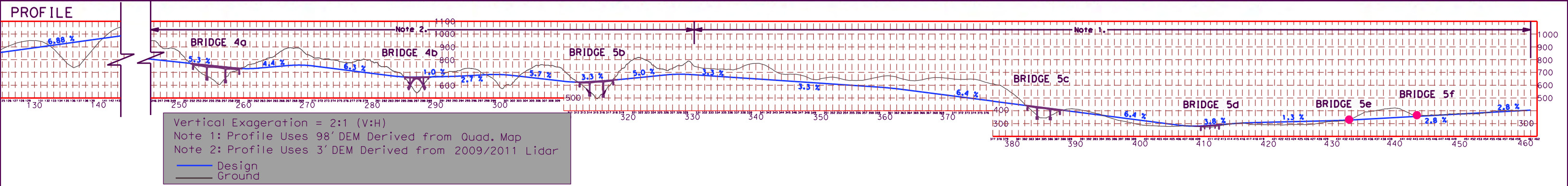

ATTACHMENT C
Typical Cross Sections

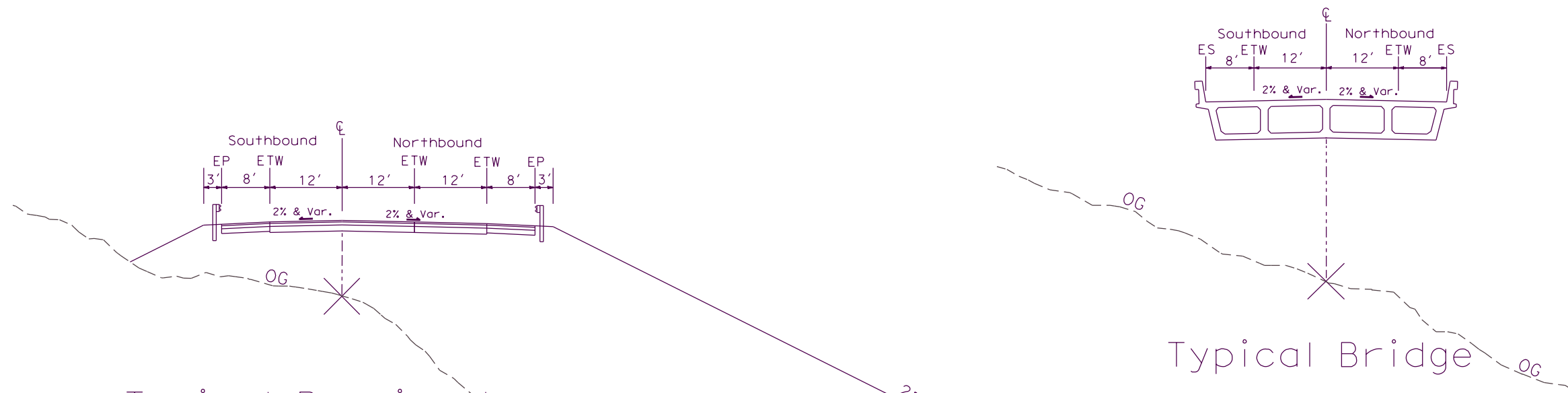

Typical Bridge

Typical Passing Lane Section On Tangent Fill
(Locations unidentified at present time)

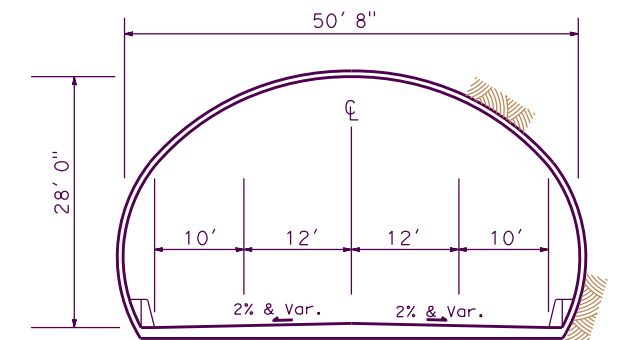
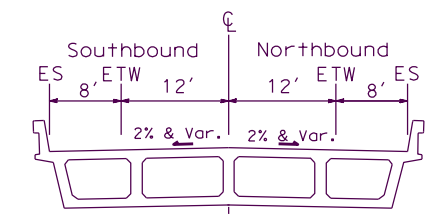

Typical Tunnel

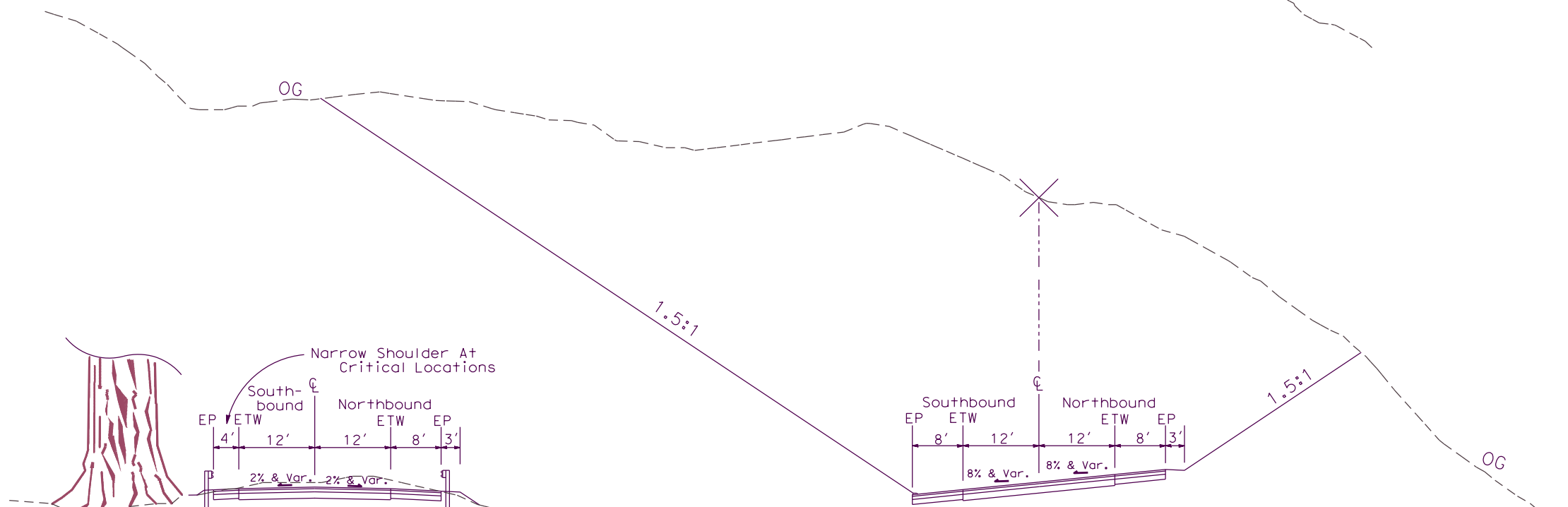

Typical 'Through-Cut' On Curve

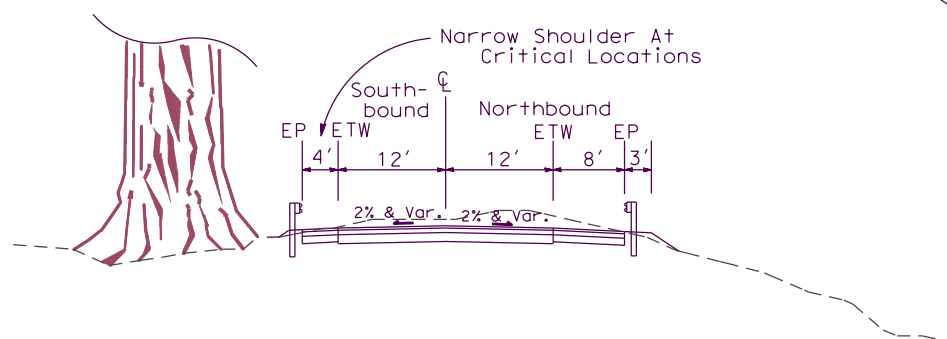

Typical Near 'Tie-in'

TYPICAL CROSS SECTIONS
(ALL ALTERNATIVES)
EA 01-0F280K